

Mérnökiroda Kft.  
Engineering Ltd.

2018 CATALOG

OPTICAL SOLUTIONS FOR  
THE INDUSTRY AND SCIENCE

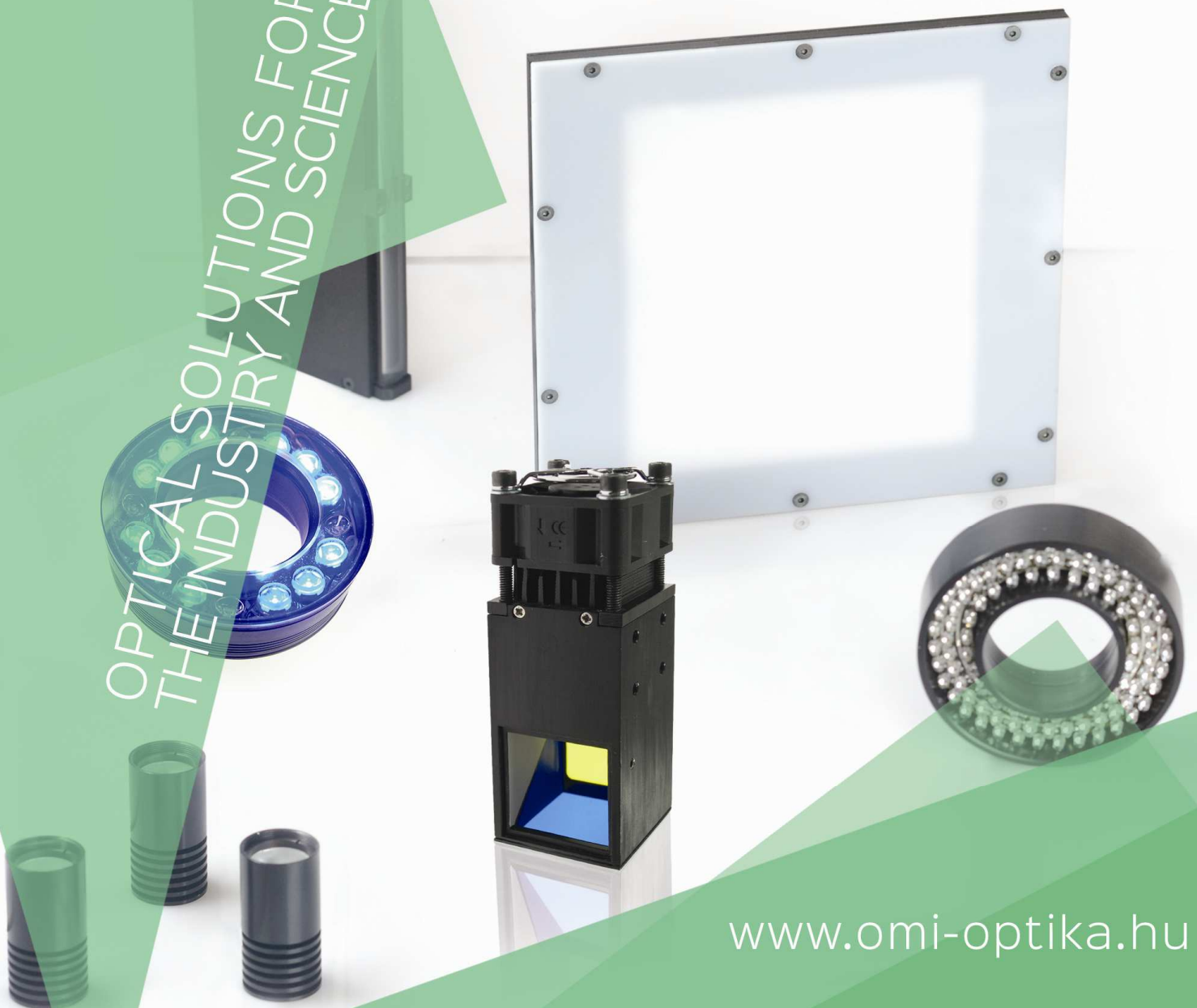



H-1121 Budapest  
Konkoly-Thege M. út 29-33

Engineering Ltd.

OMI OPTIKA Mérnökiroda Kft.

2004 ÓTA AZ IPARBAN  
OPTIKAI MEGOLDÁSOK AZ IPAR  
ÉS A MŰSZAKI ÉLET SZÁMÁRA

- ipari képfeldolgozás optikai eszközei
- ipari LED megvilágítók (UV-VIS-NIR) automatizált vizsgálatokhoz
- optikai/kamerás mérőrendszerek kivitelezése
- tervezés, fejlesztés, gyártás



[www.omi-optika.hu](http://www.omi-optika.hu)

[info@omi-optika.hu](mailto:info@omi-optika.hu)

tel.: +36 1 392 2208

# LED Ring Lights

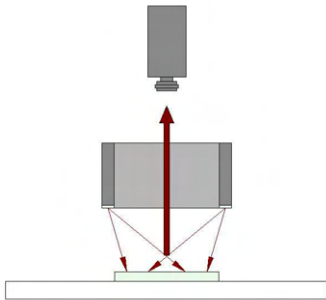

Working example

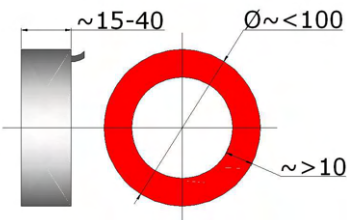

Standard Ring Light

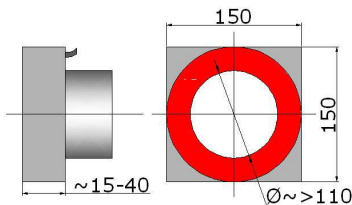

Large Area Ring Light

LED Ring Lights provide direct illumination with high and even intensity on specular or opaque surfaces. Beam angle is factory adjusted according to customers' demand on working distance (WD) and illuminated area size.

## Specifications:

- white, UV, blue, green, red or NIR light
- power requirement: 12V DC or 24V DC (please specify when ordering)
- available with power supply with optional trigger input
- continuous or strobe operation (depends on power supply)
- > 50.000 h lifetime
- robust, anodized alu or plastic housing
- designed to operate in harsh industrial environment
- please call for IP classified versions

## LED Ring Lights

Product Number	Dimensions (mm)	Light emitting surface (mm)	Wave-length (nm)	Available IP protection
3-057-000	Ø100/Ø60x29	Ø100/Ø60	white	IP65
3-060-000	Ø100/Ø45x30	Ø100/Ø45	white	IP65
3-063-000	Ø80/Ø50x30	Ø80/Ø50	375	IP65

More standard and custom versions are available.

For specific wavelength, shape, power, dimension, housing etc. visit [www.omi-optika.hu](http://www.omi-optika.hu), send a message to [info@omi-optika.hu](mailto:info@omi-optika.hu) or call +36-1-392-2278.



UV Ring Light, 395nm



White Ring Light



High power white Ring Light

# LED Darkfield Lights

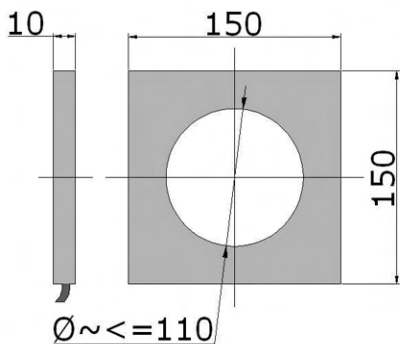
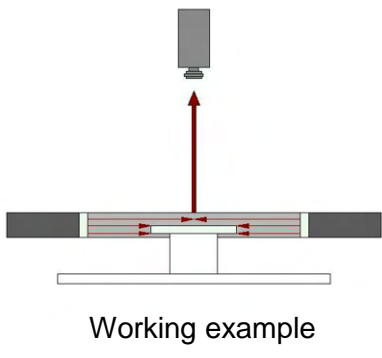

LED Darkfield (Low Angle) Lights are suitable for highlighting surface roughness, surface structure, edges with the help of light nearly parallel with the surface.

## Specifications:

- white, UV, blue, green, red or NIR light
- power requirement: 12V DC or 24V DC (please specify when ordering)
- available with power supply with optional trigger input
- continuous or strobe operation (depends on power supply)
- > 50.000 h lifetime
- robust, anodized alu or plastic housing
- designed to operate in harsh industrial environment
- please call for IP classified versions

## LED Darkfield (Low Angle) Lights

Product number	Dimensions (mm)	Illuminated area (mm)	Wave-length (nm)	Available IP protection
3-067-000	100x100x10/Ø60	Ø60	640	IP65
3-077-000	150x150x10/Ø100	Ø100	640	IP65
3-078-000	150x150x10/Ø100	Ø100	850	IP65

More standard and custom versions are available.

For specific wavelength, shape, power, dimension, housing etc. visit [www.omi-optika.hu](http://www.omi-optika.hu), send a message to [info@omi-optika.hu](mailto:info@omi-optika.hu) or call +36-1-392-2278.

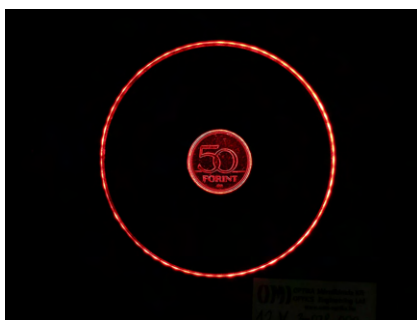

LED Darkfield light

# LED Dome Lights

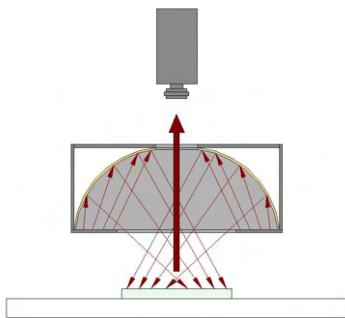

LED Dome Light

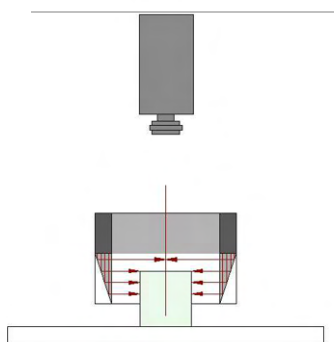

LED Low-Angle Dome Light

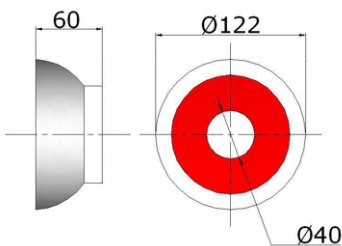

LED Dome Light  
typical dimensions

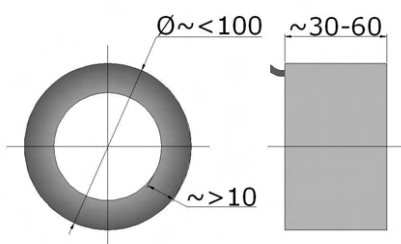

LED Low-Angle Light typical dimensions

LED Dome Lights ensure even, shadowless illumination for inspecting specular, uneven or curved surfaces. Shadows and reflections generated by the surface can be avoided this way.

## Specifications:

- white, UV, blue, green, red or NIR light
- power requirement: 12V DC or 24V (please specify when ordering)
- available with power supply with optional trigger input
- continuous or strobe operation (depends on power supply)
- > 50.000 h lifetime
- robust, anodized alu housing
- designed to operate in harsh industrial environment

## LED Dome Lights

Product number	Dimensions (mm)	Illuminated surface (mm)	Wavelength (nm)
3-087-000	Ø70/Ø30x40	Ø50	White
3-090-000	Ø122/Ø80x60	Ø80	White

More standard and custom versions are available.

For specific wavelength, shape, power, dimension, housing etc. visit [www.omi-optika.hu](http://www.omi-optika.hu), send a message to [info@omi-optika.hu](mailto:info@omi-optika.hu) or call +36-1-392-2278.

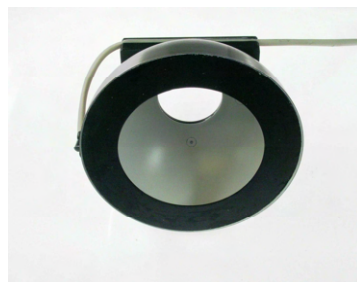

White compact LED Dom Light  
OMI 3-090-000

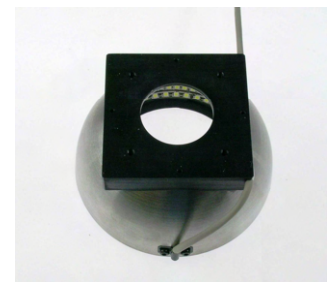

# LED Coaxial Lights

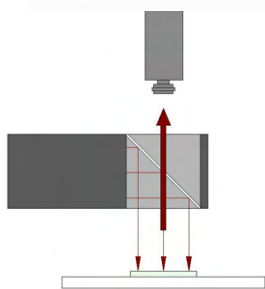

LED Coaxial Lights

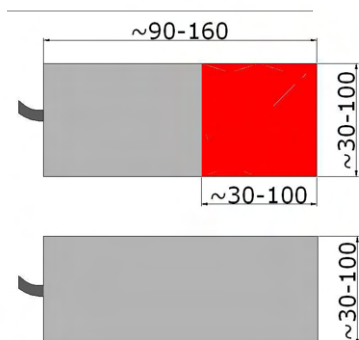

Typical dimensions

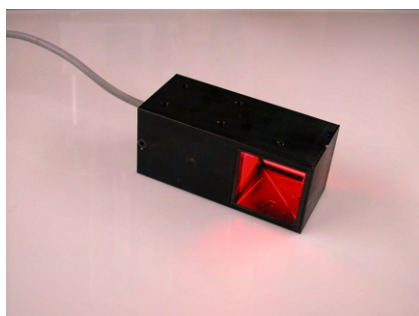

30x30 LED Coaxial Light



100x50 LED Coaxial Light

LED Coaxial Lights ensure even, diffuse, axial illumination for inspecting glossy surfaces.

## Specifications:

- white, UV, blue, green, red or NIR light
- power requirement: 12V DC or 24V DC (please specify when ordering)
- available with power supply with optional trigger input
- continuous or strobe operation (depends on power supply)
- > 50.000 h lifetime
- robust, anodized alu housing
- designed to operate in harsh industrial environment

## LED Coaxial Lights

Product number	Dimensions (mm)	Light emitting surface (mm)	Wavelength (nm)
3-304-000	110x100x60	100x50	640
3-305-600	40x40x90	30x30	640
3-310-600	40x40x73	30x30	420
3-320-600	80x110x40	29x73	420

More standard and custom versions are available.

For specific wavelength, shape, power, dimension, housing etc. visit [www.omi-optika.hu](http://www.omi-optika.hu), send a message to [info@omi-optika.hu](mailto:info@omi-optika.hu) or call +36-1-392-2278.

# Standard LED Backlights

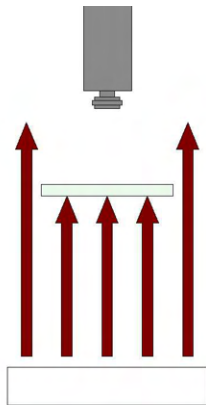

LED Back Lights

Standard LED Backlights ensure homogen illumination to display contours of objects sized up to 100 mm with high contrast. Also applicable as diffuse lighting.

## Specifications:

- white, blue, green, red or NIR light
- homogen intensity distribution
- power requirement: 12V DC or 24V DC (please specify when ordering)
- available with power supply with optional trigger input
- continuous or strobe operation (depends on power supply)
- > 50.000 h lifetime
- robust, anodized alu housing
- glass or plastic illumination surface
- designed to operate in harsh industrial environment

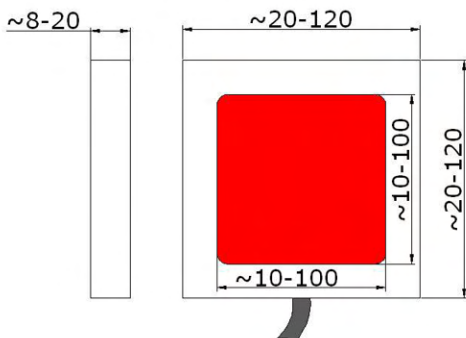

Typical dimensions

## Slim Standard Backlights:

- typical thickness: 8 to 10 mm
- illuminating area: <~50 mm x < ~50 mm

## Thin Standard Backlights

- thickness: 12 mm
- illuminating area: <~50 mm x < ~50 mm

## Thick Standard Backlights

- typical thickness: 20 mm
- illuminating area: <~100 mm x < ~100 mm

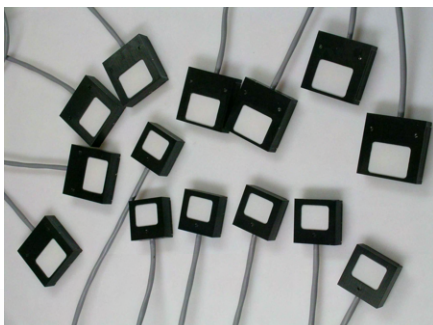

Slim Standard Backlights

## Standard LED Backlights

Product number	Dimensions (mm)	Light emitting surface (mm)	Wavelength (nm)	Available IP protection
3-201-000	100x100x20	80x80	640	IP65
3-124-000	40x40x12	24x24	red	IP65
3-125-000	50x40x12	34x34	red	IP65
3-148-000	33x40x8	24x24	red	IP65
3-216-600	170x220x16	150x200	white	IP65
3-216-700	100x300x16	80x280	white	IP65
3-220-000	50x65x20	35x60	white	IP65

More standard and custom versions are available.

# Large LED Backlights

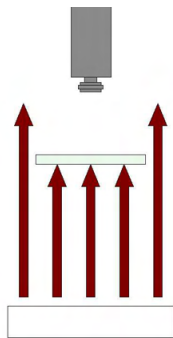

Large LED Back Lights

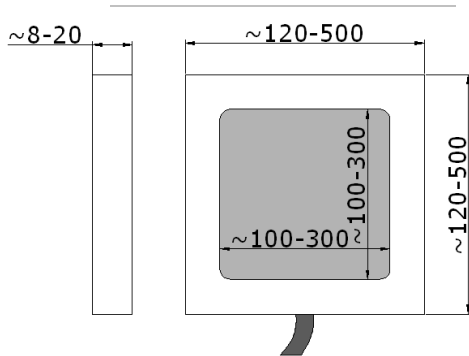

Typical dimensions

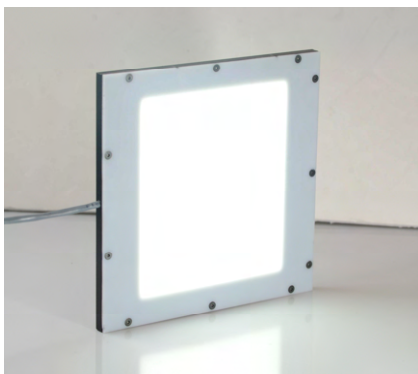

Slim Large LED Backlight

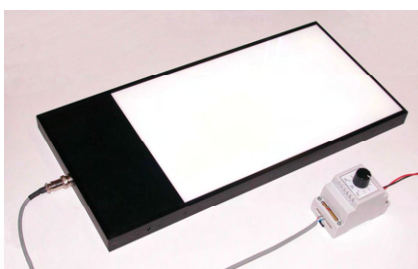

Standard Large Backlight

Large LED Backlights ensure homogen illumination to display contours of objects larger than 100 mm with high contrast. Also applicable as diffuse lighting.

## Specifications:

- white, blue, green, red or NIR light
- homogen intensity distribution
- power requirement: 12V DC or 24V DC (please specify when ordering)
- available with power supply with optional trigger input
- continuous or strobe operation (depends on power supply)
- > 50.000 h lifetime
- robust, anodized alu housing
- plastic illumination surface
- designed to operate in harsh industrial environment
- please call for IP classified versions

## Standard Large LED Backlights:

- typical thickness: 25 mm
- light emitting surface: >~100 mm x >~100 mm

## Slim Large LED Backlights (edge-lit):

- typical thickness: 10 mm
- light emitting surface: >~100 mm x >~100 mm

## Large LED Backlights

product number	Dimensions (mm)	Light emitting surface (mm)	Wavelength (nm)
3-207-000	130x190x25	100x160	Red
3-212-000	200x200x30	200x150	White
3-240-000	235x240x10	200x200	Red
3-241-000	180x180x10	120x140	White
3-242-000	133x113x10	100x80	White
3-246-000	440x240x10	400x200	Red
3-247-000	380x240x10	340x200	Red

More standard and custom versions are available.

For specific wavelength, shape, power, dimension, housing etc. visit [www.omi-optika.hu](http://www.omi-optika.hu), send a message to [info@omi-optika.hu](mailto:info@omi-optika.hu) or call +36-1-392-2278.





# LED Spot Backlights

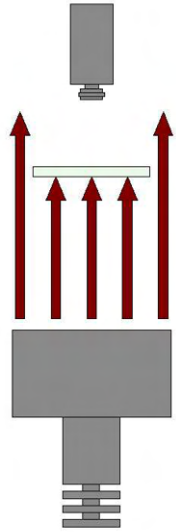

LED SPOT Backlight

LED SPOT Backlights offer extra large intensity for exposures in the microsecond range. Simple installation, no maintenance. Recommended also for limited space applications.

## Specifications:

- white, blue, green, red or NIR light
- power consumption: max. 3 W
- homogene intensity distribution
- light emitting area:  $\varnothing 35$  mm
- power requirement: constant current
- available with power supply with optional trigger input
- continuous or strobe operation (depends on power supply)
- > 50.000 h lifetime
- robust, anodized alu housing
- dimensions:  $\varnothing 40/\varnothing 25 \times 50$  mm
- plastic or glass light emitting surface
- designed to operate in harsh industrial environment
- please call for IP classified versions

**More standard and custom versions are available.**

**For specific wavelength, shape, power, dimension, housing etc. visit [www.omi-optika.hu](http://www.omi-optika.hu), send a message to [info@omi-optika.hu](mailto:info@omi-optika.hu) or call +36-1-392-2278.**



LED SPOT Backlight,  
diam. 40mm

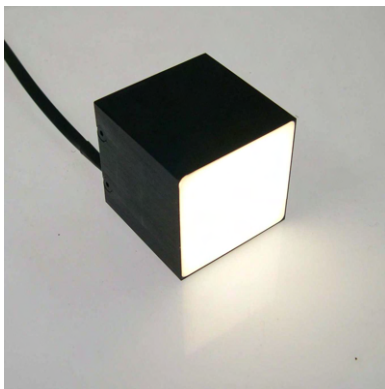

LED SPOT Backlight,  
40x40mm

# RGB LED Spot Lights

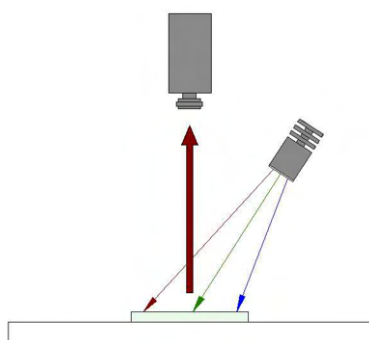

RGB LED SPOT Light



RGB LED SPOT Lights

RGB LED SPOT Lights offer three separately controllable LED chips integrated into one compact modul. A wide range of visible color gamut or white light can be achieved with integrated color mixing optics. RGB LED SPOT Lights are also available in moduls to achive greater intensity.

## Specifications:

- white or coloured light
- power consumption: max. 3 W
- beam angle: 30°
- power requirement: constant current
- separately adjustable intensity for each chip
- available with power supply with optional trigger input
- continuous or strobe operation (depends on power supply)
- > 50.000 h lifetime
- robust, anodized alu housing
- compact size:  $\varnothing 25 \times 50$  mm
- fixing with M4 screw
- designed to operate in harsh industrial environment

## Typical field of use:

- enhancing contrast depending on the color of the workpiece in machine vision inspection
- illumination with variable color at laboratory tests
- museum display cases
- artworks
- illuminations for photography

## 3x1W RGB LED SPOT Lights

Product number	Dimensions (mm)	Light emitting surface (mm)	Wavelength (nm)	Available IP protection
3-403-000	$\varnothing 25 \times 45$	$\varnothing 24$	RGB	IP65
3-411-000	$\varnothing 25 \times 45 + 120$ (goose neck)	$\varnothing 24$	RGB	IP65
3-460-600	$\varnothing 90 \times \varnothing 50 \times 20$	Illuminated area: $\varnothing 50$	420 + White	

More standard and custom versions are available.

For specific wavelength, shape, power, dimension, housing etc. visit [www.omi-optika.hu](http://www.omi-optika.hu), send a message to [info@omi-optika.hu](mailto:info@omi-optika.hu) or call +36-1-392-2278.

# LED Spot Modul Lights

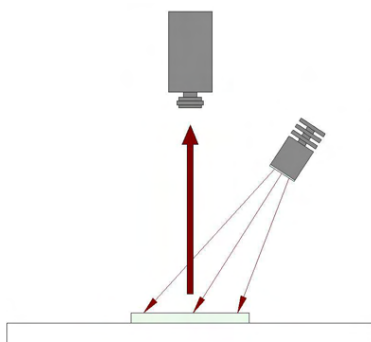

LED SPOT Light

LED SPOT Modul Lights include multiple LED SPOT Lights offering extreme intensity with maintenance-free passive cooling and individually adjustable reflectors.

## Specifications:

- power consumption: max.  $n \times 3 \text{ W}$
- beam angle: from  $10^\circ$  up to  $180^\circ$
- white, UV, blue, green, red, yellow or NIR light
- power requirement: constant current
- available with power supply with optional trigger input

## LED SPOT Modul Lights

Product number	Dimensions (mm)	Light emitting surface (mm)	Wavelength (nm)	Available IP protection
3-402-200/ 1W/3W/5W	$\varnothing 80 \times 87$	$\varnothing 18,5 \times 4 \text{ pcs}$	any color	IP65
3-456-000/ 1W/3W/5W	$200 \times 50 \times 80$	$170 \times 30$	any color	IP65



9x3W RGB Modul Light

- continuous or strobe operation (depends on power supply)
- circle, ring or line layout
- $> 50.000 \text{ h}$  lifetime
- robust, anodized alu housing with robust fixing
- designed to operate in harsh industrial environment
- please call for IP classified versions

**More standard and custom versions are available.**

**For specific wavelength, shape, power, dimension, housing etc. visit [www.omi-optika.hu](http://www.omi-optika.hu), send a message to [info@omi-optika.hu](mailto:info@omi-optika.hu) or call +36-1-392-2278.**



6x3W UV Modul Light



4x3W White Modul Light

# LED Lights for Fluor

## LED Lights for Fluorescence Imaging



LED ringlight, 365nm,  
OMI 3-063-000



LED SPOT projector, 395nm  
OMI 3-426-700

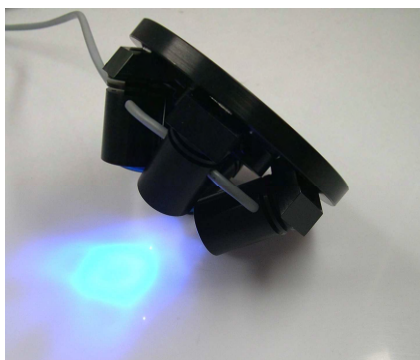

LED Module light, 395nm  
OMI 3-461-000

OMI LED Lights for fluorescence imaging are highly efficient sources of UV or dark blue lights required for getting effective and high contrast fluorescent images.

High power LED sources in fluorescent illuminators with lifetime over 50,000 hours offer a compact and economical alternative to formerly used expensive arc lamps with limited lifetime.

We offer standard and custom spot, ring and axial lights as well as replacement units for former fiber optical light sources between 365-450nm. High pass optical filters are also available with our fluorescence light systems.

High power fluorescent axial lights and fiber optical replacement lights are fan cooled assuring continuous operation. .

### Specifications:

- UV or blue light (365, 395, 400, 420nm)
- power requirement: 24VDC or constant current
- available with specific power supply with optional trigger input
- continuous or strobe operation
- > 50.000 h lifetime
- robust, anodized alu housing
- compact size
- designed to operate in harsh industrial environment

## LED Lights for Fluorescence Imaging $\lambda \leq 400\text{nm}$ (available also with $\lambda > 400\text{nm}$ )

Product number	Dimensions (mm)	Illuminated area (mm)	Wavelength (nm)
3-063-000	Ø80x30	Ø50	365
3-426-700	Ø20xØ60x20	Ø20-60	395
3-461-000	Ø125x55	Ø60	395

More standard and custom versions are available.

## LED Lights for Fluorescence Imaging, $\lambda > 400\text{nm}$ (available also with $\lambda \leq 400\text{nm}$ )

Product number	Dimensions (mm)	Illuminated area (mm)	Wavelength (nm)
3-460-600	$\varnothing 90 \times \varnothing 50 \times 20$	$\varnothing 50$	420 + White
3-310-600	40x40x73	30x30	420
3-320-600	80x110x40	29x73	420
3-418-600	$\varnothing 55$	fiber optics replacement	420
3-418-700	$\varnothing 25$	fiber optics replacement	420

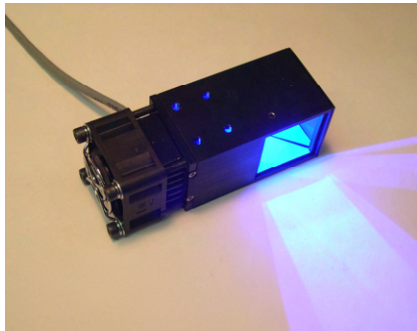

Coaxial LED Light, 420nm  
OMI 3-310-600

More standard and custom versions are available.

For specific wavelength, shape, power, dimension, housing etc. visit [www.omi-optika.hu](http://www.omi-optika.hu), send a message to [info@omi-optika.hu](mailto:info@omi-optika.hu) or call +36-1-392-2278.

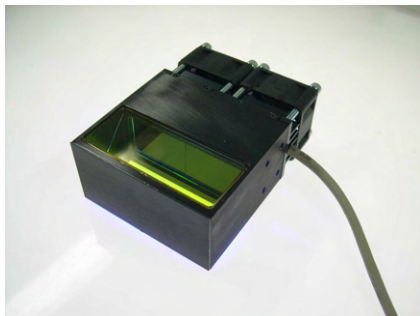

Coaxial LED Light, 420nm  
OMI 3-320-600

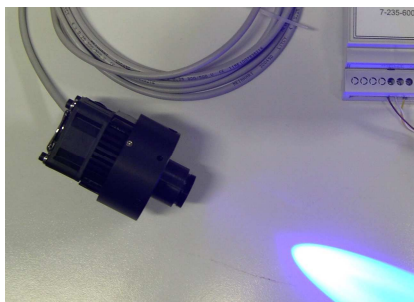

LED Lights for fiber optic replacement, 420nm  
OMI 3-418-600



OMI 3-418-700



High power LED Ring Light, dual wavelength (white/420nm)  
OMI 3-460-600

# LED Spot Lights

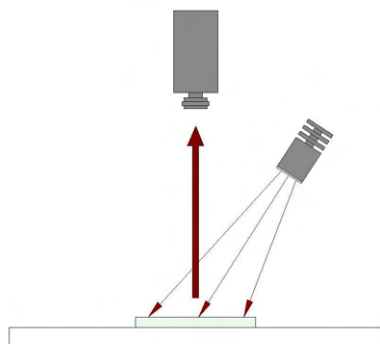

LED SPOT Light

LED SPOT Lights including one power LED offer high intensity for a wide range of application with maintenance-free passive cooling.

## Specifications:

- white, blue, green, red or NIR light
- power consumption: max. 3 W
- beam angle: 8°, 30°, 50° or 10°x50°
- power requirement: constant current
- available with power supply with optional trigger input
- continuous or strobe operation (depends on power supply)
- > 50.000 h lifetime
- robust, anodized alu housing
- compact size:  $\varnothing 25 \times 50$  mm
- fixing with M4 screw
- cable outlet on the side
- designed to operate in harsh industrial environment
- please call for IP classified versions



LED SPOT Lights

## Typical field of use:

- products, workpieces
- laboratory tests
- machine vision measurements, calibrations
- microscopic inspections
- workpieces to be machined (eg. milling, lathing etc.)



LED SPOT Light with gooseneck

## LED SPOT Lights

Product number	Dimensions (mm)	Light emitting surface (mm)	Wavelength (nm)	Available IP protection
3-402-000/ 1W/3W/5W	$\varnothing 25 \times 45$	$\varnothing 18,5$	any color	IP65
3-410-000/ 1W/3W/5W	$\varnothing 25 \times 45 + 120$ (goose neck)	$\varnothing 18,5$	any color	IP65

More standard and custom versions are available.

For specific wavelength, shape, power, dimension, housing etc. visit [www.omi-optika.hu](http://www.omi-optika.hu), send a message to [info@omi-optika.hu](mailto:info@omi-optika.hu) or call +36-1-392-2278.

# LED Spot Projectors

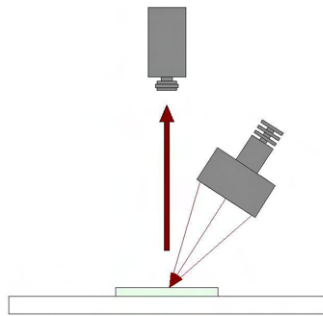

LED Spot Projector

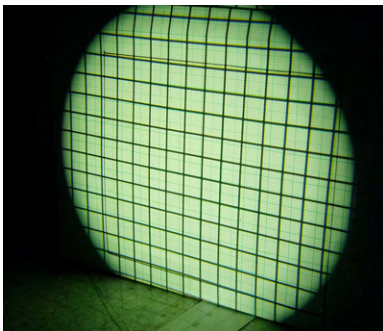

Typical pattern

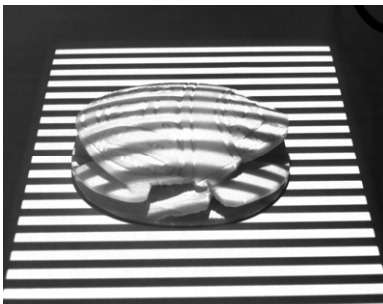

Projector for 3D scanning



LED SPOT Projector with fixed focus



LED SPOT Projector with interchangeable C-mount lens

LED SPOT Projector Lights illuminate workpieces of any size with a Structured Light. Usually optimised for a given distance, but also available with focusable optics.

We offer LED SPOT Projectors to project light spots with definite size or diameters, or with any pattern e.g. for 3D scanning.

## Specifications:

- power consumption: max. 3 W
- projecting distance: max. ~3 m
- white, blue, green, red or NIR light
- available with custom size or pattern (Structured Light)
- even intensity distribution
- power requirement: constant current
- available with power supply with optional trigger input
- continuous or strobe operation (depends on power supply)
- > 50.000 h lifetime
- robust, anodized alu housing
- compact size:  $\varnothing 25 \times 50$  mm
- fixing with M4 screw
- cable outlet on the side
- designed to operate in harsh industrial environment
- please call for IP classified versions

**More standard and custom versions are available.**

**For specific wavelength, shape, power, dimension, housing etc. visit [www.omi-optika.hu](http://www.omi-optika.hu), send a message to [info@omi-optika.hu](mailto:info@omi-optika.hu) or call +36-1-392-2278.**

# LED Line Lights

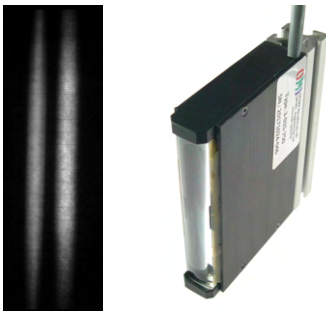
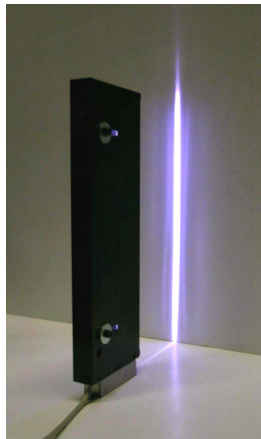
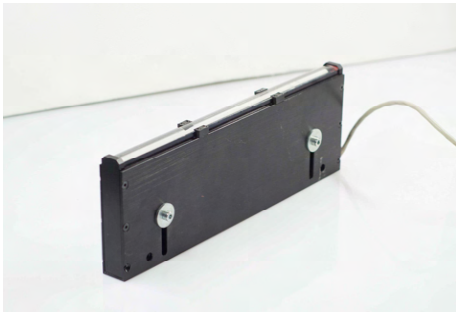

LED Line Lights with single or dual wavelength

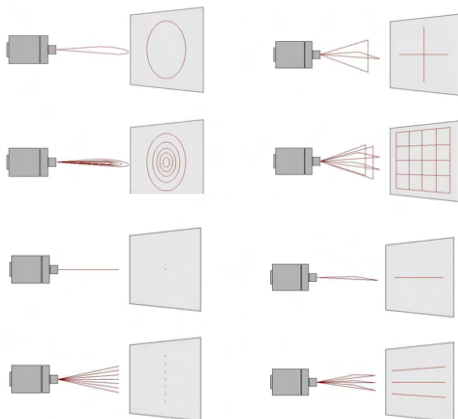

Typical Laser Patterns

LED Line Lights illuminate objects, signs, labels, or workpieces passing in front of a sensor e.g. a line-camera. Direct line illumination is a special lighting used in industrial machine vision automated inspections.

## Specifications:

- LED light source projecting a straight line with high intensity
- plastic cylindrical lens
- white, blue, green, red or NIR light
- compact, anodized alu housing
- fixing with M5 screws
- working distance: 50-200 mm, focusable or fix
- > 50.000 h lifetime
- length of illuminated area: 50-300 mm
- width of illuminated area: 3-20 mm
- power requirement: 24 VDC
- available with power supply with optional trigger input
- continuous or strobe operation (depends on power supply)

## LED Line Lights

Product number	Dimensions (mm)	Light emitting surface (mm)	Wavelength (nm)
3-015-000	250x60x20	250x10	White
3-015-750	90x87x20	80x15	NIR + White

## Professional Laser Illuminations

### Specifications:

- diffractive optics without moving parts, maintenance-free
- structured laser light
- focusable
- power requirement: 5V DC
- available with power supply with optional trigger input
- professional semiconductor laser chips
- designed to operate in harsh industrial environment
- robust, anodized aluminium housing
- available with adjustable fixing

### Typical patterns:

- dot, dot-series
- line, parallel lines
- cross, grid
- circle, concentric circles
- custom patterns are also available on demand

More standard and custom versions are available.

For specific wavelength, shape, power, dimension, housing etc. visit [www.omi-optika.hu](http://www.omi-optika.hu), send a message to [info@omi-optika.hu](mailto:info@omi-optika.hu) or call +36-1-392-2278



# LED Light Sources for Fibers

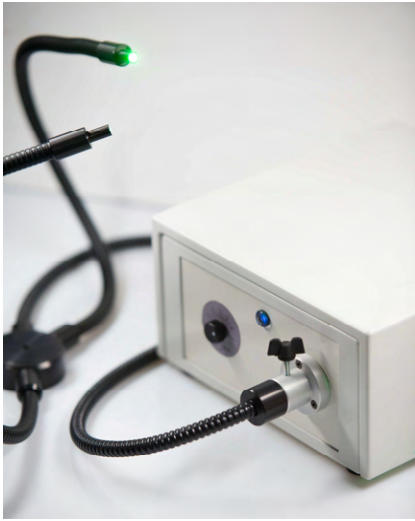

LED Light Sources for Fiber Optics offer longlife illumination for fiber optics application. Tens of thousands of hours lifetime, dimmable, constant color temperature.

Flexible or semi-rigid fibers are available with custom length and with focusable optics.

## Specifications:

- nominal max. luminous flux: 1500 lm
- dimming with front panel knob or via Trigger Input
- dimensions: 250 x 220 x 117 mm
- power source: 230 V AC, max. 50 W
- short-driven external trigger
- thermal protection with internal heatswitch
- weight: 2,6 kg
- > 50.000 h lifetime
- available with custom wavelength LEDs

## LED Light Source for Fiber Optics

Product number	Dimensions (mm)	Fiber connection dimension	Fiber diameter
3-650-000	250x220x117 mm	Ø14x37 mm	Ø6 mm
3-650-500	250x220x117 mm	Ø8,4x30 mm	Ø1 mm

More standard and custom versions are available.

For specific wavelength, shape, power, dimension, housing etc. visit [www.omi-optika.hu](http://www.omi-optika.hu), send a message to [info@omi-optika.hu](mailto:info@omi-optika.hu) or call +36-1-392-2278.



LED Light Sources for  
Fiber Optics



Focusable Optics

# LED Matrix Lights

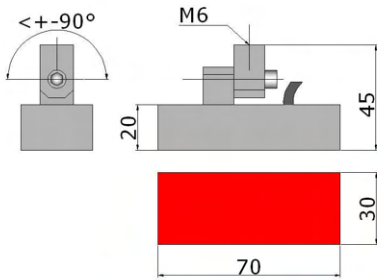

Typical dimensions

LED Matrix Lights illuminate objects, signs, labels or workpieces with light emitted by a large surface area. This kind of direct illumination offers high intensity for a wide range of application.

## Specifications:

- white, UV, blue, green, red or NIR light
- power source: 12V DC or 24V DC
- available with power supply with optional trigger input
- continuous or strobe operation (depends on power supply)
- > 50.000 h lifetime
- robust, anodized alu housing
- compact size
- fixing with M4 screw
- designed to operate in harsh industrial environment



White LED Matrix Lights

## LED Matrix Lights

Product number	Dimensions (mm)	Light emitting surface (mm)	Wavelength (nm)
3-005-000	40x20x22	32x16	640
3-001-000	70x30x45	64x26	630
3-002-000	70x30x45	64x26	880
3-003-000	70x30x45	64x26	white

More standard and custom versions are available.

For specific wavelength, shape, power, dimension, housing etc. visit [www.omi-optika.hu](http://www.omi-optika.hu), send a message to [info@omi-optika.hu](mailto:info@omi-optika.hu) or call +36-1-392-2278.

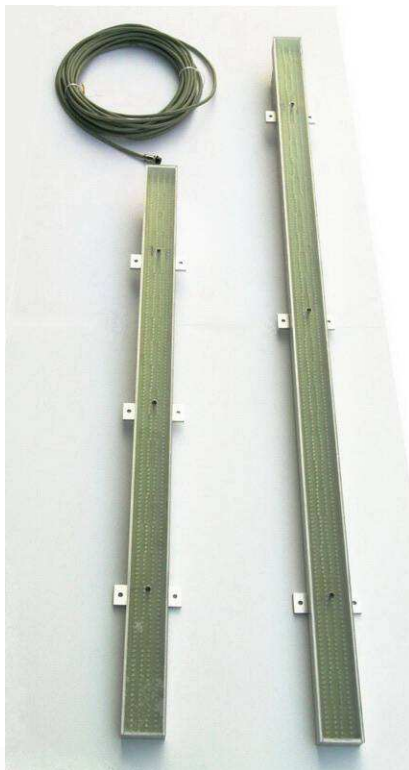

NIR LED Matrix Lights

# LED Power Supplies



Power Supply with built in knob



Power Supply with multiple outputs



Power Supply with trigger input and multiple outputs

LED Power Supplies and Drivers are available in several versions depending on user requirements: dimmable, triggerable, with one or more outputs, typically with DIN rail mounting.

Because of the varied fields of applications, details must be specified when ordering.

## Specifications:

- switched-mode circuits
- available dimmable with built in knob or analog signal
- available with external trigger input
- typical versions:
  - o 12V DC or 24V DC input, constant current output
  - o 230V AC input, constant current output
  - o 230V AC input, 5V DC, 12V DC or 24V DC output
- available with multiple outputs
- DIN rail mounting
- flickerless technology

## LED Power Supplies

Product number	Input / Output	Dimming/Triggering
7-219-600	24 VDC / 24 VDC	trigger + knob
7-219-700	24 VDC / 12 VDC	trigger + knob
7-227-600	24 VDC / 700 mA	trigger + knob
7-227-700	24 VDC / 700 mA	trigger
7-235-600	24 VDC / 950 mA + 24 VDC	trigger
7-235-900	24 VDC / 1500 mA	built in knob

More standard and custom versions are available.

For specific wavelength, shape, power, dimension, housing etc. visit [www.omi-optika.hu](http://www.omi-optika.hu), send a message to [info@omi-optika.hu](mailto:info@omi-optika.hu) or call +36-1-392-2278.

# Optical Accessories

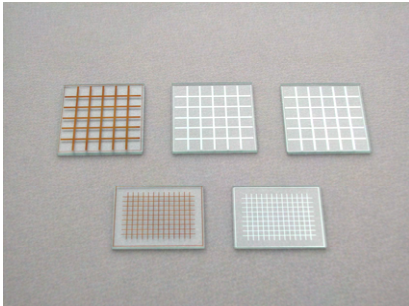

Optical microstructures  
for calibration

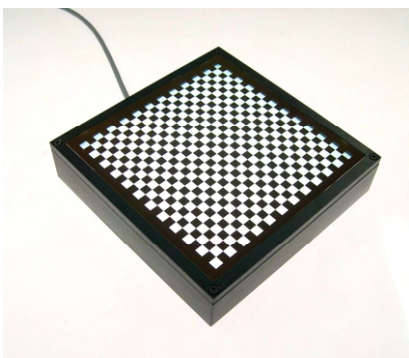

Chessboard calibration plate  
with back illumination

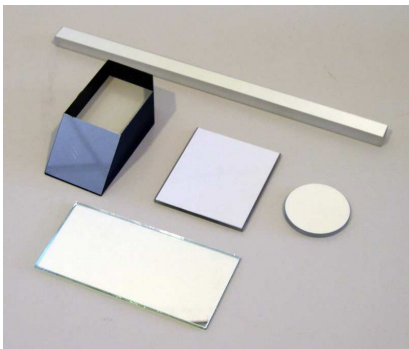

Optical mirrors



C-mount spacers

## Optical microstructures for calibration

We offer optical microstructures for calibration and measurement purpose. Micrometer-range precision, microlitographic technology. Please call for custom figures and substrates. Large printed versions are available as well.

## Optical Mirrors

We manufacture and refurbish front or rear surface aluminium coated mirrors.

## Extension tubes, spacer rings

We manufacture and offer extension tubes and spacers for C-mount lenses and for other kind of industrial optics. Custom length and versions with electronically isolated threads are available as well.

## Optical filters for Machine Vision

Low pass, high pass, bandpass, polarisation and other filters are available.

**More standard and custom versions are available.**

**For specific wavelength, shape, power, dimension, housing etc. visit [www.omi-optika.hu](http://www.omi-optika.hu), send a message to [info@omi-optika.hu](mailto:info@omi-optika.hu) or call +36-1-392-2278.**



Optical filters

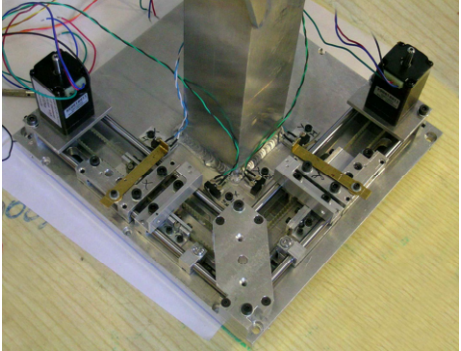
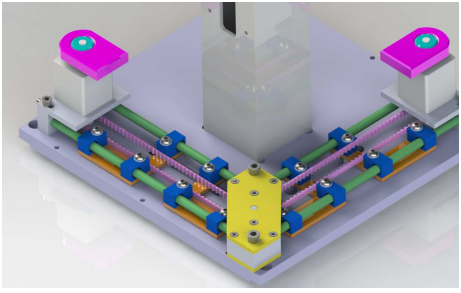

High precision aperture for  
neutron imaging

### Optical and optomechanical systems and devices

We design, develop, produce and install optical and optomechanical devices and equipments.

Please call for in-line machine vision equipments for non-contact quality inspection.

We design, develop and manufacture optomechanical devices for research and science.

### Restoring and refurbishing optical devices

#### Restoring, repairing

We restore historical optical devices and instruments, achieving the original and functional condition: surveying instruments e.g. theodolites, old binoculars, astronomical telescopes etc. We repair, renew, restore and clean binoculars, riflescopes and other optical devices.

#### Refurbishing, modernization

We refurbish, functionally repair, renew and calibrate optical devices, instruments and tools by repairing or replacing the optical, mechanical and electrical components: industrial microscopes, optical instruments, projection microscopes etc.

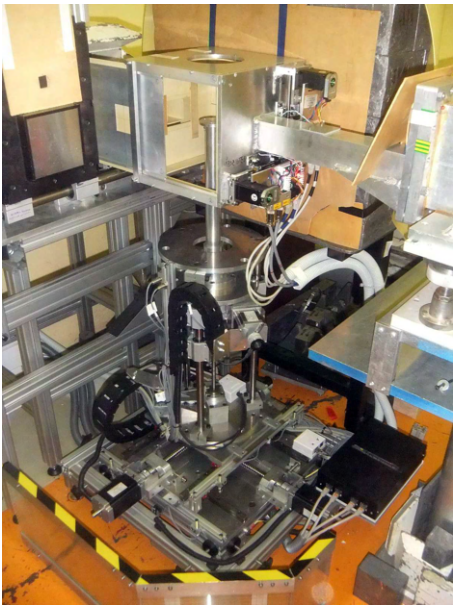

PGAA – NIPS neutron  
tomograph

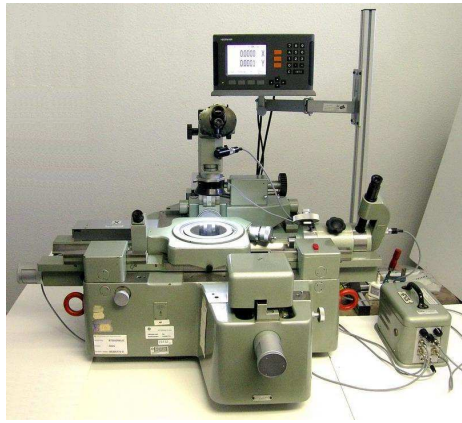

Refurbished X-Y measuring  
microscope



Renewed heliometer  
Fraunhofer 1817

# Machine Vision Lenses



## Machine

- Production
- Control
- Logistics

## Vision

- Up to 12 MP
- Compact design
- Ultra-low distortion

## Systems

- CMOSIS compatible
- 4K Board
- Infra-Red Solutions

## Telecentric Lenses

## Macro Optics

## 360° Optics



**computer**

**OPTO ENGINEERING**  
THE TELECENTRIC COMPANY

tel.: +36 1 392 2208



A XXVI. Magyar Innovációs Nagydíj bírálóbizottsága

az OPTIKA Mérnökiroda Kft.-t

elismerésben részesíti a 2017. évben megvalósított

„Új fejlesztésű, multispektrális és fluoreszcens LED megvilágítások ipari képfeldolgozási feladatokhoz”

c. jelentős innovációért.

2018. március 28.

Dr. Pálincás József  
Nemzeti Kutatási, Fejlesztési és  
Innovációs Hivatal elnöke,  
a bírálóbizottság elnöke

Prof. Závodszky Péter  
akadémikus  
a Magyar Innovációs Alapítvány  
elnöke

Dr. Gyöngyös Sándor  
a Magyar Innovációs Szövetség tiszb. elnöke,  
a szervezőbizottság elnöke

- LED megvilágítások és szűrők  
fluoreszcens alkalmazásokhoz

- LED fényforrások száloptikai  
megvilágításhoz

- objektívek, szűrők,  
közgyűrűk, tükrök



## OPTO ENGINEERING és COMPUTAR objektívek hazai forgalmazója

- ipari objektívek  
akár 12 MP-ig  
alacsony torzítással

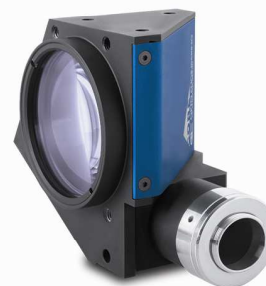

- SWIR objektívek

- telecentrikus  
objektívek



OPTO ENGINEERING

computar®

[www.omi-optika.hu](http://www.omi-optika.hu)

[info@omi-optika.hu](mailto:info@omi-optika.hu)

Mérnökiroda Kft.  
OMI OPTIKA Engineering Ltd.

H-1121 BUDAPEST, Hungary  
Konkoly-Thege M. út 29-33

[info@omi-optika.hu](mailto:info@omi-optika.hu)

[www.omi-optika.hu](http://www.omi-optika.hu)

+36 1 392 2278

+36 30 950 1135